



















POWERMOON[®]
LED



Ambient Lighting
One Stop Energy Efficient Solutions

CONTENTS	Voltage AC / DC	Wattage	Most suitable for		
			CONSTRUCTION	Police / EMS Firerescue	Event / Leisure
6 POWERMOON® SL 2000	100V (AC) - 230V (AC)	320W			
7 POWERMOON® LEDMOON®	230V (AC)	500W 650W			
8 POWERMOON® PAVERMOON®	120V (AC)- 230V (AC)	650W			
9 POWERMOON® LED-MASTER	12V or 24V DC	400W 700W			
10 POWERMOON® TRANSFORMER	230V (AC)	540W 1090W			
12 POWERMOON® LIGHTWING®	12V&24V(DC) & 230V (AC)	160W			
13 POWERMOON® PARTYMOON®	230V (AC)	320W			
14 POWERMOON® POCKETMOON®	230V (AC) & 12V (DC)	130W			
16 POWERMOON® FIBERJACK® TRIPODS					
17 POWERMOON® SLIDER MINI-LIGHT-TOWER					
Gallery: Paving / Construction					
Gallery: Police / EMS / Firerescue					
Gallery: Event / Festival / Leisure					
Gallery: Sport					



⑥ POWERMOON® SL 2000



⑦ POWERMOON® LEDMOON®
⑧ POWERMOON® PAVERMOON®
⑨ POWERMOON® LED-MASTER



⑩ POWERMOON® TRANSFORMER



⑫ POWERMOON® LIGHTWING®



⑬ POWERMOON® PARTYMOON®



⑭ POWERMOON® POCKETMOON®



⑯ POWERMOON® FIBERJACK®
TRIPODS



⑰ POWERMOON® SLIDER
Mini-Light-Tower



For **25 years** and counting, POWERMOON's company name has been synonymous with durability, reliability, craftsmanship and precision.

Advantages of POWERMOON® LED technology

Patented 'Umbrella Style' Technology

POWERMOON® balloon lights are robust and durable! This technology guarantees that the balloon can't accidentally collapse, such as gas filled or air inflated balloons.

High Portability

A POWERMOON® lighting balloon is small in storage and easy to set up within seconds. 2 POWERMOON® fit in a trunk of a small sedan car, but they are equivalent to a conventional light tower.

Safety

Daylight conditions at night wherever needed! Safe and efficient teamwork guaranteed!

More And Better Lighting

A balloon light is glare free, shadow reduced and spreads light in a 360° circle without any dark spots.



POWERMOON® Quality

Top of the line LED technology and the most durable materials for the harshest working conditions

German Engineering

POWERMOON® lighting balloons are Made In Germany

POWERMOON®
USA - Headquarters



POWERMOON®
Germany - Headquarters



Flawless Light Quality

Just about any kind of light can be bright, but only POWERMOON® balloon lights cast natural, bright, daylight-quality light in a perfect 360-degree circle. The design of the balloon guards against glare and eliminates dark spots. The result is a safer, more efficient work environment for your entire team, passersby or even in residential areas and neighborhoods.

Portable And Easy To Use Anywhere

Good construction lights and good work lights need to be set up and put down easily. And really great construction lights can be mounted on any machine and any set up. POWERMOON® LED construction light balloons are up to these standards. Our lights can be packed up and set up again within mere seconds. In fact 10-12 complete light sets can easily be loaded onto one pick up truck to light long stretches of highway.

Tough As Nails And Weather Resistant

Whether you are in heavy or light construction, it is not just about the light quality. Construction workers are required to be able to work under the toughest conditions: Hot asphalt, stones, sand and gravel, no matter how necessary, might be in the way. These materials interfere with your tools, not always in a positive way. Hot asphalt sticks to surfaces, stones cut in to fabric etc. On top a huge variety of weather conditions like rain and fog, brutal sunshine and cold nights have an impact not only on you but also on the tools. Naturally the equipment which contractors count on needs to be able to operate under those conditions.

POWERMOON® LED balloon lights are built to withstand those impacts and to withstand mother nature. In fact our lights don't just use any other companies LED light bar like so many other lights! We design and manufacture our LED systems in house. We only use the highest quality of LED diodes and mount them on our very own specialized cooling and operating solutions which will satisfy the high standards we and our customers require. We also use only high end materials and components on the balloon light design itself and have developed the most reliable open close system with our 'umbrella style technology' (no air pressure involved) to make sure: Our lights will hold up in tough work and harshest weather conditions.

POWERMOON®, We Have Your Lighting Needs Covered

When you are in construction, your safety and the integrity of your work are vitally important, so you don't want to trust just any lighting company with your needs. That is why the world's biggest, most successful construction companies make POWERMOON® their first choice. While we are very proud of that trust, it also reminds us to constantly strive for improving and updating our technology and our service.

Further LED advantages:

- No frequency flickering
- No bulb breakage
- No cool down time
- Instant on/off
- Long service life of the LED cells
> 50,000 hours (OEM data)
exp. avg. 20,000 hours
- Resistant to vibration and shock



POWERMOON® worklights are bright but diffuse the light and get rid of all glare. The result is clear vision with plenty of light all around 360°. No eye fatigue and perfect communication.

POWERMOON[®] 120V - 230V LED SL2000

EASY - AFFORDABLE
PRACTICAL - BRIGHT



The POWERMOON[®] SL2000
is the entry-level model of the POWERMOON[®] series

„SL“ stands for: super light, 48,000 lumen bright

„SL“ stands for: super light, only 9kg



IP 54

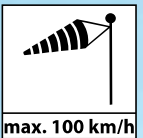

max. 100 km/h

THE POWERMOON[®] SL 2000 LED Package Deal

SL2000 & small aluminium tripod
up to 3,20 meter & tie down set

Thanks to innovative POWERMOON[®] balloon light technology!

- Glare free Light
- Instant On/Off Technology
- Fast Lock „Pull-Down“ solution
- Protection Type IP54, thus rain and weather proof (Continuous use)
- Bottom Cover out of Spinnaker-Nylon
- Made entirely in fiberglass, corrosion-free stainless steel and aluminium
- New LED technology without power supply – Plug in and ready!
- Vibration resistant by LED technology
- Patented spring mechanism system
- No more Cool-down time
- Wind resistant up to 100 km/h
- No flickering of the light
- Hanging loop

As bright as 2000W
tungsten halogen!
But only requires
320W!

Protection class Protection insulation	<input type="checkbox"/>	POWERMOON [®] SL2000
Wattage :		320W
Voltage :		100V-230V/ 40-150Hz
Current :		1.4A / 230V
Type of protection :		IP 54
Light amount :		ca. 48 000 Lumen
Light color :		6000K, daylight quality, CRI >80
Balloon weight :		9kg
Ballon dimensions :		D=1040mm H=680mm
Transport packaging :		L=1140mm x D=250mm
min. Generator W :		500 Watt





Our Trademark „LEDMOON“ always stands for a 230V unit which is plug in ready!

The POWERMOON® LEDMOON® 230V/AC Balloon lights work without an additional power supply. Just plug it in and light it up!



Fold-out suspension-hook

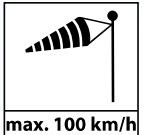

Pull open technology opens balloon light through a simple pull on a cable!



Thanks to innovative POWERMOON® balloon light technology!

- Glare free light
- Powermoon® wind-resistant up to 100 km/h
- Patented, robust spring-screen mechanism
- With new, fast lock-in „Pull-Down“ solution
- Manufactured completely from anti-corrosion stainless steel and aluminium
- Bottom diffusion cover made of glare free spinnaker nylon with great light transmission
- Reflector-cover made from robust, durable fiberglass / aramide woven material
- IP54 protected, rain and water resistant (permanent outside use)

Thanks to LED technology !

- No frequency flickering
- No bulb breakage
- No cool down time
- Instant on/off
- Resistant to vibration and shock
- New LED technology without power-pack - plug in ready

Protection class Protection insulation	□	POWERMOON® LEDMOON® 400
Wattage :		500W
Voltage :		230V / 50-60Hz
Current :		2,2A / 230V
Type of protection :		IP 54
Light amount :		ca. 50 000 Lumen
Light color :		5500K, daylight quality, CRI >80
Balloon weight :		11kg
Ballon dimensions :		D=900mm H=600mm
Transport packaging :		L=1140mm x D=250mm
min.Generator W :		500 Watt

Protection class Protection insulation	□	POWERMOON® LEDMOON® 600
Wattage :		650W
Voltage :		230V / 50-60Hz
Current :		2,9A / 120V
Type of protection :		IP 54
Light amount :		ca. 75 000 Lumen
Light color :		5500K, daylight quality, CRI >80
Balloon weight :		12kg
Ballon dimensions :		D=900mm H=600mm
Transport packaging :		L=1140mm x D=250mm
min.Generator W :		700 Watt



POWERMOON® PAVERMOON® is the new best possible light solution for any paving or construction machine. The **POWERMOON® PAVERMOON®** with around **75.000 lumens** comes with **6 independent drivers** which makes the light **fail proof against fluctuating current and corrects the flow of voltage.**

AS BRIGHT AS 3000W TUNGSTEN HALOGEN !

POWERMOON® balloon light technology!

- Glare free light
- Powermoon® wind-resistant up to 100 km/h
- Patented, robust spring-screen mechanism
- With new, fast lock-in „Pull-Down“ solution
- Manufactured completely from anti-corrosion stainless steel and aluminium
- Bottom diffusion cover made of glare free spinnaker nylon with great light transmission
- Reflector-cover made from robust, durable fiberglass / aramide woven material
- IP54 protected, rain and water resistant (permanent outside use)

Thanks to LED technology !

- No frequency flickering
- No bulb breakage
- No cool down time
- Instant on/off
- Resistant to vibration and shock

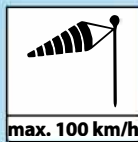

Protection class Protection insulation	<input type="checkbox"/>	POWERMOON® PAVERMOON®
Wattage :		650W
Voltage :		100V-230V/ 50-60Hz
Current :		5A at 120V / 2.7A at 230V
Type of protection :		IP 54
Light amount :		ca. 75 000Lumen
Light color :		5500K, daylight quality, CRI >80
Balloon weight :		12kg
Ballon dimensions :		D=900mm H=600mm
Transport packaging :		L=1140mm x D=250mm
min. Generator W :		1000 Watt



POWERMOON® LED-MASTER



The **POWERMOON® LED-MASTER®** balloons are particularly suitable for operation on road pavers, road rollers or other construction machines by using it directly with the on-board voltage system. Pre-sets for either **12 volts or 24 volts**. The complete cable kit for operation on the vehicle's battery including the power socket for body installation and a **DC high-current switch** are included with the light!

Supplied cable lengths:

From the battery to the power outlet: 4 meter.
 From the DC power plug to the POWERMOON® master light 7 meter.
 Special cable lengths for larger vehicles on request.

Our product term „**MASTER**“ always stands for a **battery-operated 12V or 24V light**. Suitable for multiple voltages with **AC/DC power-pack**

12V or 24V

- Glare free light
- No frequency flickering
- Powermoon® wind-resistant up to 100km/h
- No bulb breakage
- No cool down time
- Instant on/off
- Patented, robust spring-screen mechanism
- With new, fast lock-in „Pull-Down“ solution
- Resistant to vibration and shock due to LED technology
- New LED technology without power-pack - plug in ready
- Ballast is no longer necessary - 10kg lighter than previous model
- Manufactured completely from anti-corrosion stainless steel and aluminium
- Bottom diffusion cover made of glare free spinnaker nylon with great light transmission
- Reflector-cover made from robust, durable fiberglass / aramide woven material
- IP54 protected, rain and water resistant (permanent use)
- Low voltage regulation / extra-low voltage area

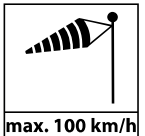

With optional power supply also usable on household voltage!

12V / 24V - 1000W
 DC power-pack
 IP54

The complete cable kit for operation on the vehicle's battery including the power socket for body installation and a DC high-current switch are included with the light!



Protection class 3 Extra-low voltage area	POWERMOON® LED-MASTER 400	POWERMOON® LED-MASTER 700
	Wattage : 400W	700W
	Voltage : 12V/24V DC	12V/24V DC
	Current : 41A → 12V / 20A → 24V	70A → 12V / 35A → 24V
	Protection Class : IP 54	IP 54
	Light amount : ca. 50 000 Lumen	ca. 100 000 Lumen
	Light color : 5500K, daylight quality, CRI >80	5500K, daylight quality, CRI >80
	Ballon weight : 11kg	12kg
	Ballon dimensions : D=900mm H=600mm	D=900mm H=600mm
	Transport packaging : L=1340mm x D=250mm	L=1340mm x D=250mm
	Accu/alternator capacity : >80Ah (for 12V vehicle) >40Ah (for 24V) vehicle	>120Ah (for 12V vehicle) >60Ah (for 24V) vehicle



From textile light balloons to remote controlled high performance LED lights.
POWERMOON® TRANSFORMER with 150.000 Lumens in a radial light field of 100 meters.

POWERMOON® TRANSFORMER - A new innovative textile free light system with the same qualities of the balloon light. Compared to our existing range of products, the POWERMOON® TRANSFORMER impresses with its **150.000 lumen** by making it completely unique on the competitive market.

Superlight and stable carbon frame



**150.000
Lumen**

Adjustable lightfield

Only 7cm flat /13kg



The **6 triangular light segments** of the POWERMOON® TRANSFORMER can be adjusted individually to create a light field with the right intensity and angle suitable for your exact needs.

Angle 0°



10
Meter

Angle 30°



40
Meter

Angle 50°



100
Meter

The new **POWERMOON® TRANSFORMER** has an **IP65** rating and uses a high performance fanless **self-cooling system** by also staying **super lightweight** with a modern Aluminium and Magnesium casting.

The frame of the POWERMOON® TRANSFORMER is made out of impact and fall resistant Carbon Tubes and the Aluminium pressure cast cooling profiles enables optimal heat removal with minimal layer thickness and weight. The new light saves space by being more compact - with a height of only 7 cm and a diameter with just 77cm, making it easy to transport. A Carrier bag is included with the light.



High-performance cooling system

Unlimited optimization for your lighting purposes.

The new **POWERMOON® TRANSFORMER** is equipped with **manual dimming** over a switch connected to the cable and also via **bluetooth remote-control** over the new POWERMOON® Mobile App. The particularly innovative feature of the POWERMOON® App is that it is the first on the market providing "Long-Distance-Control" for the lights from a distance of 50-100 meters.

The light of the **POWERMOON®** can be comfortably remote controlled while driving past them in a car or while sitting in a container up to 100 meters away from the **POWERMOON® TRANSFORMER**. The lights communicate with each other through Bluetooth so you have the option of controlling the lights on a highway up to 15km with just one click ON or OFF on the POWERMOON® Mobile App. Additional features include an automatic ON/OFF switch for the lights on your chosen hours and days or with the option of opening or closing the lights automatically at sunrise/sunset.

- Dim and switch the light on/off manually or with the all new POWERMOON® Smartphone App
- Glare-free as if you would have a balloon textile, but without a textile cover
- Self cooling / passive cooling without fan
- Watertight (IP65)
- Adjustable lightfield

- Turn On or Off
- Dimming
- Group Control

- Weekly Calendar
- Group Assignment
- Delay Dimming

- Info Overview
- Network



	POWERMOON® TRANSFORMER 25.000	POWERMOON® TRANSFORMER 50.000	POWERMOON® TRANSFORMER 75.000	POWERMOON® TRANSFORMER 150.000
Lamps Output :	180W	360W	540W	1090W
Power Source :	220-240V / 50-60Hz	220-240V / 50-60Hz	220-240V / 50-60Hz	220-240V / 50-60Hz
AC/DC :	0,8A bei 230V	1,6A bei 230V	2,4A bei 230V	4,7A bei 230V
IP type :	IP 65	IP 65	IP 65	IP 65
Lightoutput :	25 000 Lumen	50 000 Lumen	75 000 Lumen	150 000 Lumen
Lightcolor :	5700K, Daylight quality	5700K, Daylight quality	5700K, Daylight quality	5700K, Daylight quality
Weight :	3kg (5kg in Transport case)	6kg (8kg in Transport case)	9kg (11kg in Transport case)	13kg (15kg in Transport case)
Dimensions :	D=330x500mm H=70mm	D=600x500mm H=70mm	D=690x780mm H=70mm	D=690x780mm H=70mm
Dimensions of Case :	D=710x800mm H=90mm	D=710x800mm H=90mm	D=710x800mm H=90mm	D=710x800mm H=90mm
Generator Power:	300 Watt	500 Watt	700 Watt	1200 Watt

POWERMOON® LED LIGHTWING®

The Portable Multi-Voltage High Performance LED Beam

AC connection



C13 Plug AC
230V



Adjustable glare protection shield protects passing traffic from looking in to light source



Impact resistant glare protection glass made from polycarbonate

Hand grip on both sides

DC connection



Battery Plug DC
12-24V

POWERMOON® LIGHTWING® is the right choice for those looking to have bright, high quality LED light in specific places rather than illuminating a whole area such as with a balloon light. **POWERMOON® LIGHTWING®** - fast set up and does not require any cool down time. Equipped with rotating swivel heads **POWERMOON® LIGHTWING®** is adjustable and versatile and mount to practically any machine as well as tripod set ups. **POWERMOON® LIGHTWING®** is robust, wind and weather resistant.

Disruptive Technology! One light, all voltages!
AC/DC system without the need for a transformer

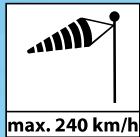

max. 240 km/h



1x

POWERMOON® LIGHTWING® SINGLE

Wattage :	160W
Input Voltage DC/Amp:	12/24V DC
Input Voltage AC/Amp:	230 V/50-60 HZ / 0,7 A
Type of protection :	IP 67, Waterproof
Amount of light :	19 200 Lumen
Colour of light :	6000K, Daylight Quality, CRI >80
Spotlight weight :	5kg
Spotlight dimensions :	L=560mm B=150mm H=120mm

2x

POWERMOON® LIGHTWING® DUO

Wattage :	2x160W
Input Voltage DC/Amp:	12/24V DC
Input Voltage AC/Amp:	230V/50-60 HZ / 1,4 AIP 67,
Type of protection :	Waterproof
Amount of light :	2x19 200 Lumen
Colour of light :	6000K, Daylight Quality, CRI >80
Spotlight weight :	10kg
Spotlight dimensions :	L=560mm B=150mm H=120mm



The new POWERMOON® LIGHTWING® series!
Designed with multi-voltage capability, this beam floodlight is available in different versions and can be used on vehicles and machines. Equipped with glare protection shields and 360° adjustable positions, the POWERMOON® LIGHTWING® is slim, bright and super durable.

POWERMOON® LED PARTYMOON®

The all new attractive POWERMOON® PARTYMOON® with remote RGB control

The new POWERMOON® PARTYMOON® (RGB) is a self inflatable balloon for events, parties, advertising, exhibitions, garden and landscape lighting. You can use it on a tripod or hang it from the ceiling (usable inside and outside).

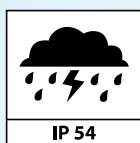

The POWERMOON® PARTYMOON® is a festival and event decoration. It is **not** suitable for permanent outdoor use or outdoor advertising and it is **not storm stable!** For example you can use it as an eyecatcher permanently inside a shopping mall.



Protection class Protection insulation	<input type="checkbox"/>	POWERMOON® PARTYMOON®
Wattage :	320W	
Voltage :	120-230V/ 40-150Hz	
Current :	1,4A at 230V	
Type of protection :	IP 54	
Light amount :	ca. 48 000Lumen	
Light color :	6000K, daylight quality, CRI >80	
Balloon weight :	9 kg	
Ballon dimensions :	D=1000mm	
Transport packaging :	L=1140mm x D=250mm	
min.Generator W :	500 Watt	

POCKETMOON[®]

BY

POWERMOON[®]
LED



120V - 230V



12V

NEW!

The first foldable LED light solution with the qualities of a balloon light without any textile!



Weight only 500 gr. !
Fits in any pocket

Waterproof

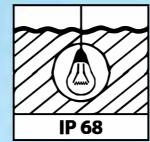

- Usable both on **230V AC** and **12V DC** battery power
- Comes with a stainless steel tripod with total height of 3,5m
- The light comes with a swivel head to set the direction of the light and uses a magnetic connector to link it to the tripod or any other magnetic surface
- Glare free light in a radius of 9m
- No cool down time
- Instant on/off
- Resistant to vibration and shock thanks to LED technology
- Manufactured completely from anti-corrosion stainless steel and aluminium
- IP68 protected, rain and water resistant (permanent use)



Daylight for any situation!



POCKETMOON[®] SET

3,5 meter stainless steel tripod with swivel head and magnetic connectors



LED panels



230V AC Power supply & cable



Alligator clips for car battery



Car adapter

For using with:



Household plug



battery



Car

Practical illumination for nighttime flagger operations. Use a 120 Amp/h truck battery instead of a patrol generator and the Pocketmoon[®] runs for 48h noise and exhaust free.



Optional item:

- Lithium-ion battery pack
- 10 Amp's !
- 4 hours running time !



POWERMOON® FIBERJACK®

The new POWERMOON® Fiberglass Tripod

The new and outstanding fiberglass tripod offers enormous advantages compared to conventional tripods. **POWERMOON®** fiberglass tripods are non-corrosive and non-conductive. As a result, there is no longer any danger in rail tracks or overhead power lines. The bending of the tripod segments is history now, as fiberglass finds its way back into its initial form.

Weighing just 10kg at a **maximum height of 3,20m** makes the fiberglass tripod an absolute lightweight among the tripods. Compared to a commercially available steel telescope tripod, it is about 30% of the weight with the same maximum telescope length.

FIBERJACK® COMPACT

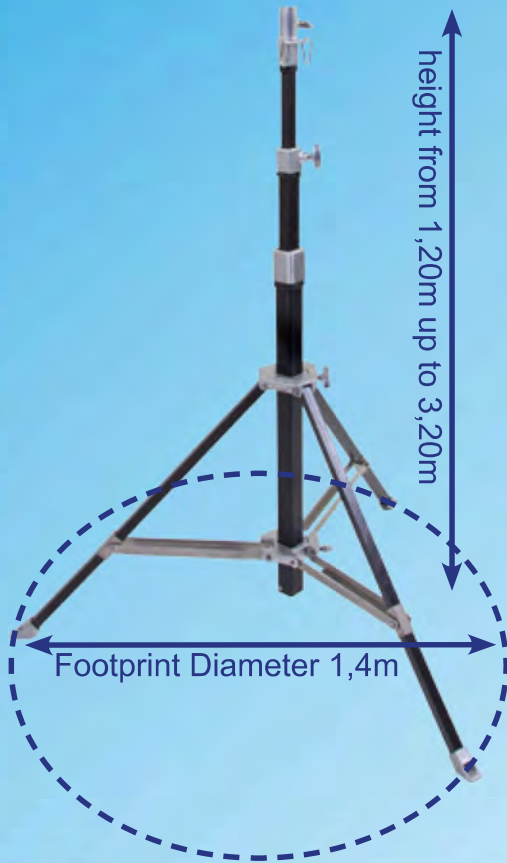

FIBERJACK® GRAND

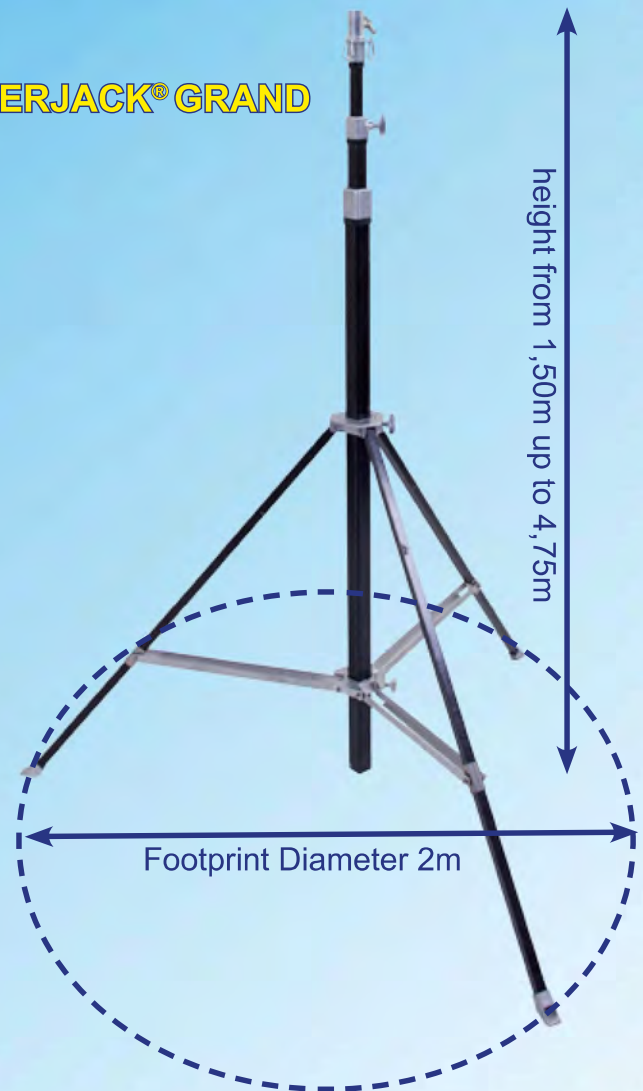

FIBERJACK®	FIBERJACK® COMPACT	FIBERJACK® GRAND
max. Height :	3,20 Meter	4,75 Meter
Transportlength :	1,22 Meter	1,75 Meter
Weight :	9,9 kg	14,2 kg
Material :	Fiberglass composite (GRP)	Fiberglass composite (GRP)
Amatures :	Aluminium / stainless steel	Aluminium / stainless steel
Tripod Intake :	DIN standard spigot / swivel head	DIN standard spigot / swivel head
Headweight :	25 kg	25 kg

* included tie down set

Tie down set included



POWERMOON® SLIDER Mini-Light-Tower

The most efficient and economic light tower

The new portable **POWERMOON® SLIDER** can be used as a Mini-Light-Tower, but also as a safe stand for mobile traffic lights, warning / information signs and temporary roadblocks.

- **Completely made out of plastic**
(plastic with fiberglass load, no need for grounding, no risk of corrosion)
- **No tie down set needed**
- **Maximum road safety**
(full-round collision protection, without sharp corner or edges)
- **Storm-proof stand**
(stand with 250l of water)
- **Super portable**
(25kg Tansportweight)
- **Maximum height**
(going up to 6 meter)



Generator mounting surface
Length x width 680 x 500 mm



1200mm
800mm

Possible to
hook on a
crane

Forklift access on the bottom

What is the difference between a Conventional Light-Tower and a POWERMOON® Mini-Light-Tower?

IN THE PAST
conventional light tower

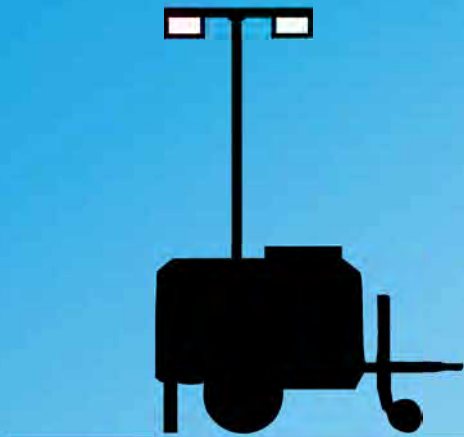

TODAY POWERMOON®
LED



POWERMOON® Mini-Light-Tower needs less space and creates a safer work environment on a highway

Conventional Light Tower
endanger the passing traffic !

POWERMOON® **Mini-Light-Tower**
is as windstable as a conventional
light tower, has a smaller footprint
and less traffic influence.

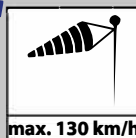
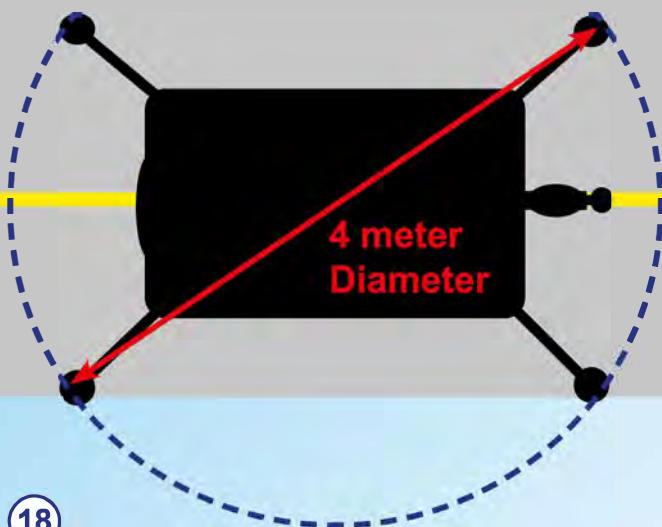

Bird eye view

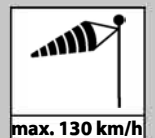
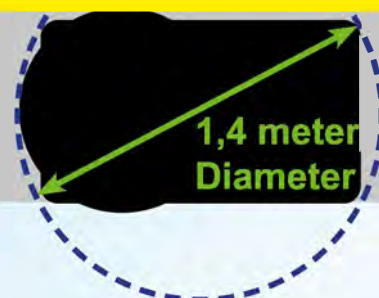

POWERMOON[®]
LED PRACTICAL SOLUTIONS



50 POWERMOON[®] Mini-Light-Towers cover a 5 km long highway with perfect and safe illumination.



PAVING AND CONSTRUCTION



EMERGENCY SERVICES



EVENT / FESTIVAL / LEISURE



SPORT



POWERMOON[®]
LED



Ambient Lighting

Pearl Assurance House
263 Lord Street
Southport
PR8 1NY
Tel 01704 514777
Fax 01704 536 892